

Introducing 3DXpert™ Version 14

Facilitate Metal Additive Production

3DXpert is an all-in-one integrated software for professionals to prepare and optimize 3D CAD designs for metal Additive Manufacturing (AM). Supporting every step of the additive manufacturing workflow from design to post-processing, 3DXpert streamlines your process to quickly and efficiently transition from a 3D model to successfully printed parts.

Key software benefits allow you to :

- Enable successful, quality prints – prepare designs for additive manufacturing
- Optimize design structure – get the most out of additive manufacturing, e.g. lighter weights, enhanced functional properties, etc.
- Shorten design to manufacturing lead-time – streamline your preparation and optimization workflow
- Minimize manufacturing Total Cost of Operation (TCO) - e.g. reduce print time, material consumption, post-processing

3DXpert continues to bring new value to each of these objectives in this latest release with a special focus on capabilities required to move from rapid prototypes to serial production.

Key Features & Enhancements

Support Multiple Print Heads

Increase Production Throughput while Maintaining Seamless Part Quality

Printing time is a key factor of AM throughput and is an increasingly crucial issue as parts are getting bigger. Multiple print heads enable 3D printing time to shorten dramatically thus increasing the manufacturing throughput and making AM a feasible option for serial production.

Challenge : One of the challenges that multi-head printers are facing is how to synchronize multiple lasers for simultaneous operation to eliminate seam lines and degraded internal build quality.

Solution : 3DXpert auto-balancing control enables the best quality at minimum printing time for 3D Systems' multi-head DMP Factory 500. Intelligent multi-laser control ensures best utilization and balancing of the multiple print heads for high throughput production of multiple parts or large parts, up to the size of the full build volume. 3DXpert also makes sure there is a perfect merging of volumes printed by different printing heads, from the inner layers to the outer surface and the user is given control over the merge technologies used to fuse the multiple lasers operation for a single part. This results in seamless large prints with outstanding material properties and the highest surface quality for metal 3D printed parts.

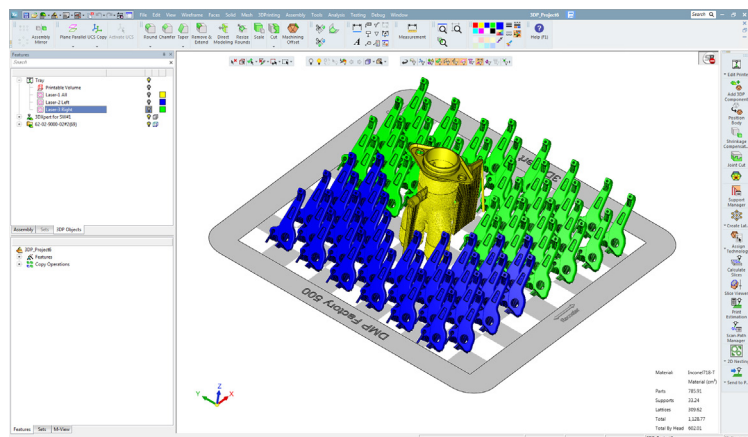

Multiple parts printed by 3 different heads on the new DMP Factory 500 printer. The blue and green parts are printed using different print heads while the yellow part is printed using all three print heads.

Enhanced Orientation

Shorten Preparation Time with Better User Control

Part orientation on the build plate has a critical impact on the quality of the print and its success rate, dictating which areas will face downwards and which areas will need supports. These areas tend to have rougher surface textures, which can be improved in some cases using labor-intensive machining tools; in other cases, these issues cannot be resolved. 3DXpert's powerful positioning tool allows orientation control for best results based on various criteria like printing time, amount of supports, material consumption and more.

Challenge : Setting design-specific criteria for part orientation to achieve better outcomes, including setting rules, eliminating orientations in which areas requiring the best quality are assigned to have supports or to face downwards, and analyzing stress estimations as stress can heavily affect the feasibility of a successful print and quality.

Solution : The orientation restriction tool enables users to select faces or facets that should not receive supports or face downwards. The auto-orientation tool uses these restrictions while making its calculations, thus eliminating degraded surface quality and reducing post-processing operations as less supports and post-processing need to be used. New best fit positioning allows users to set their own priority for each criterion and automatically get the best fit positioning that meets those targets. Stress approximation was also added as a new analysis tool for design decisions as well as to the criteria list for best fit positioning.

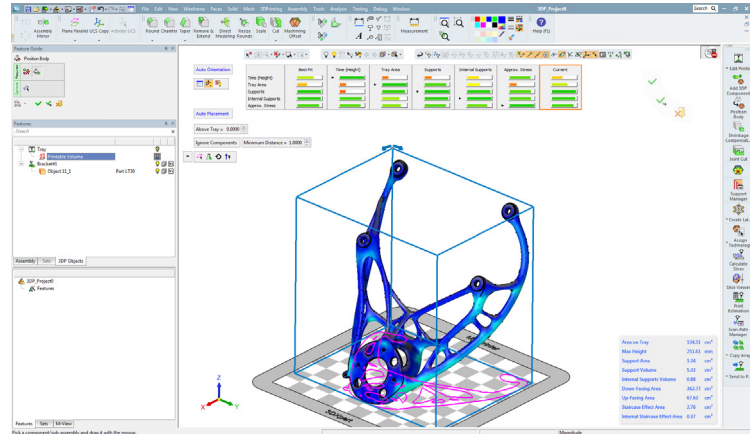

Stress based auto orientation

Smart Production Labeling

Enhance Serial Production Throughput

Labels are used to easily identify each of the parts placed on the build tray or the tray itself. Labels can be used to track the exact production batch and location on the tray in case such analysis is required.

Challenge : Labels used in serial production need to be changed constantly to follow the production sequence. When labels become part of the model, a time consuming re-slicing calculation is required. A method is required to change labels without having to re-slice and hatch parts, so that the production process does not change.

Solution : Smart labeling allows users to add variable label text to parts after they are positioned on the tray without the need to re-slice each uniquely labeled part. A label's text can be added on the part itself or to a special detachable label. The valuable time savings enabled through this feature allows for higher production throughput and better utilization of the printing facilities.

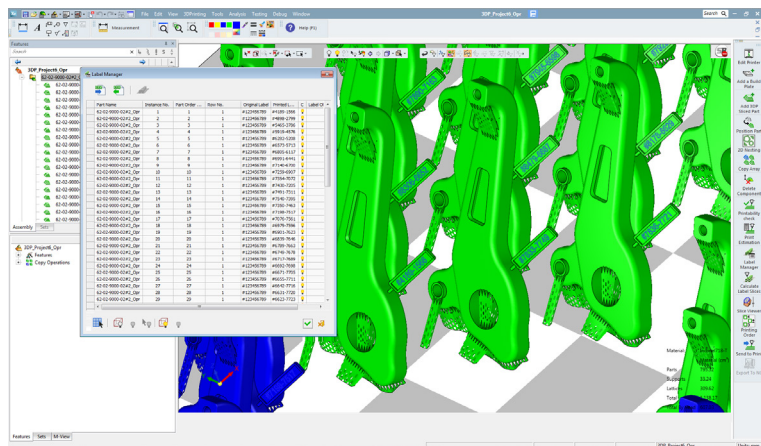

The new detachable labels applied alongside smart labeling

Optimized Lattice Structures

Enhanced Part Properties and Lower Cost

Lattice structures are a commonly used strategy to lower the weight of a part and to enhance its functional properties while maintaining its outer shape

Challenge : Serial production should achieve the best possible part properties with minimum build cost. Optimized lattice structures may introduce increased cost savings in a number of ways, from the direct cost savings of lower print times and lower material consumption to the indirect cost savings gained by enhancing a part's functional properties.

Solution : 3DXpert's lattice structures have been further optimized through several means:

- New custom-made lattice structures optimized for specific uses
- Manual controls to fine-tune existing structures
- New level of freedom to define how lattice cells progress to fill the volume.
- FEA based lattice optimization further enhance lattice structures

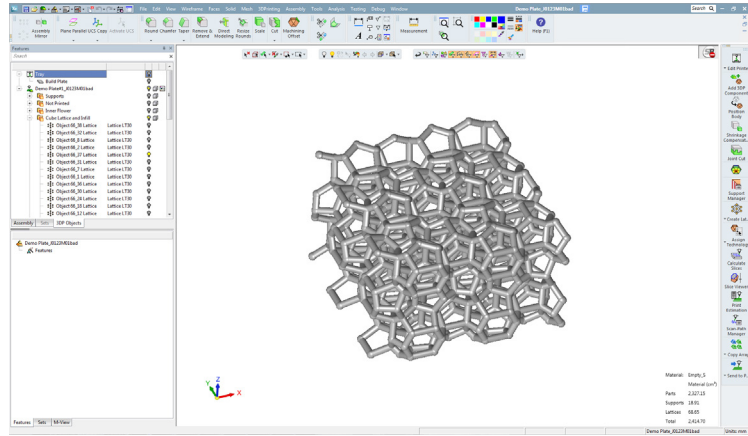

The new Weaire-Phelan lattice structure

Faster and Enhanced Simulation

Shorten Design to Manufacturing Lead-time

Build simulation ensures a successful print that meets the model specifications, helps the user to optimize the design, and minimizes the number of tryouts.

Integrated within the design environment build simulation provides designers with immediate feedback on their design decisions. For example, orientation, number of supports (both too few and too many), and part printability. This is of particular importance when printing costly or large volume parts.

Challenge : As a computing intensive operation, simulation can take a long time to perform, both in general and for large parts in particular. It therefore slows down the process of preparing a design for print. In order for fault prediction to be as accurate as possible, post-processing operations like heat treatments should also be covered.

Solution : New Build Simulation enhancements enable faster simulation cycles and now include heat treatments and compensated models for heat treatments within the simulation options.

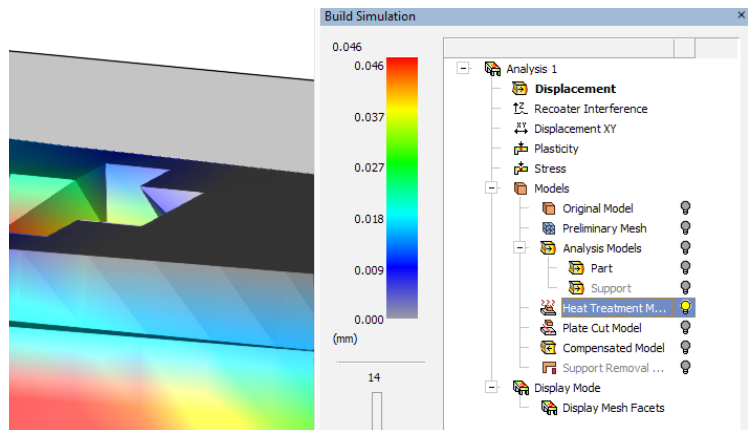

The new heat treatment option on the build simulation result tree

Customized and Best Practice Templates

Shorten Preparation Time

Template-based settings allow for the faster creation of supports and lattice structures, thus facilitating the preparation and optimization process for AM.

Challenge : Leveraging the industry-leading expertise of 3D Systems' On Demand Manufacturing services and Customer Innovation Centers (CICs) while maintaining the flexibility to change and adjust templates based on in-house experience to fit the needs of a specific design.

Solution : Introduction of new best practice templates and the ability for users to edit and save their own templates to shorten preparation time and eliminate costly mistakes that can result from using the wrong parameters. These capabilities allow users to achieve optimal results that best suit their specific part structure and surface quality requirements.

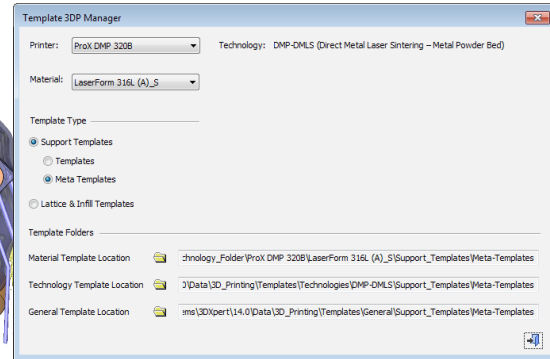
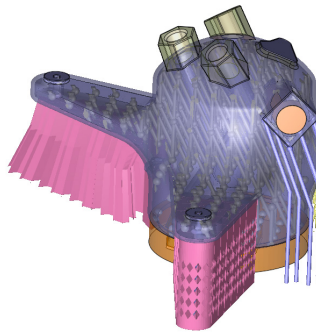

The new template manager directing to general, technology and material templates

Facilitate Engineering Change Orders (ECO)

Quickly Respond to Changes

Requests to modify the model for new requirements or to address new issues are quite frequent in the engineering world.

Challenge : Depending on the timing of a requested change, the original model may have already gone through some of the preparation stages such as setting the orientation, creating supports, adding lattice structures, etc. Modifications to the model require restarting those processes from the beginning.

Solution : 3DXpert logs user design decisions and definitions throughout the preparation stages. This new ECO support enables users to import the modified model and automatically apply all the operations of the original model, replacing a time consuming manual operation with a fast, automatic mechanism.

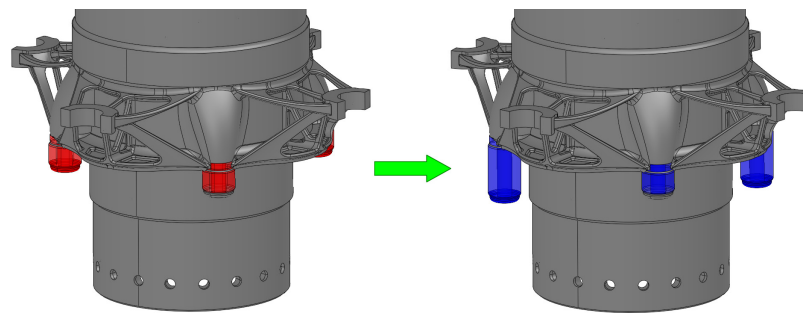

The engineering change will be applied to the model replacing the red geometry with the blue one

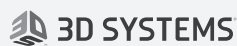

Find out more at: www.3dsystems.com/software/3dexpert

3D Systems provides comprehensive 3D products and services, including 3D printers, print materials, on-demand parts services and digital design tools. Its ecosystem supports advanced applications from the product design shop to the factory floor to the operating room. As the originator of 3D printing and a shaper of future 3D solutions, 3D Systems has spent its 30 year history enabling professionals and companies to optimize their designs, transform their workflows, bring innovative products to market and drive new business models. Specifications subject to change without notice. 3D Systems, the 3D Systems Logo, 3DXpert and the 3DXpert logo are trademarks of 3D Systems, Inc. All other trademarks are the property of their respective owners.